

METHOD 8041

PHENOLS BY GAS CHROMATOGRAPHY

1.0 SCOPE AND APPLICATION

1.1 Method 8041 describes open-tubular, capillary column gas chromatography procedures for the analysis of phenols, using both single-column and dual-column/dual-detector approaches. The following RCRA target analytes can be determined by this method:

Compound Name	CAS No. ^a	Appropriate Technique				
		3510	3520	3540	3550	3580
4-Chloro-3-methylphenol	59-50-7	X	X	X	X	X
2-Chlorophenol	95-57-8	X	X	X	X	X
2-Cyclohexyl-4,6-dinitrophenol	131-89-5	X	ND	ND	ND	LR
2,4-Dichlorophenol	120-83-2	X	X	X	X	X
2,6-Dichlorophenol	87-65-0	X	ND	ND	ND	X
2,4-Dimethylphenol	105-67-9	X	X	X	X	X
Dinoseb (DNBP)	88-85-7	X	ND	ND	ND	X
2,4-Dinitrophenol	51-28-5	X	X	X	X	X
2-Methyl-4,6-dinitrophenol	534-52-1	X	X	X	X	X
2-Methylphenol (o-Cresol)	95-48-7	X	ND	ND	ND	X
3-Methylphenol (m-Cresol)	108-39-4	X	ND	ND	ND	X
4-Methylphenol (p-Cresol)	106-44-5	X	ND	ND	ND	X
2-Nitrophenol	88-75-5	X	X	X	X	X
4-Nitrophenol	100-02-7	X	X	X	X	X
Pentachlorophenol	87-86-5	X	X	X	X	X
Phenol	108-95-2	DC(28)	X	X	X	X
2,3,4,5-Tetrachlorophenol	4901-51-3	ND	ND	ND	ND	ND
2,3,4,6-Tetrachlorophenol	58-90-2	X	ND	ND	ND	X
2,3,5,6-Tetrachlorophenol	935-95-5	ND	ND	ND	ND	ND
2,4,5-Trichlorophenol	95-95-4	X	X	ND	X	X
2,4,6-Trichlorophenol	88-06-2	X	X	X	X	X

^a Chemical Abstract Service Registry Number.

DC = Unfavorable distribution coefficient (number in parenthesis is percent recovery).

LR = Low response.

ND = Not determined.

X = Greater than 70 percent recovery by this technique.

1.2 The single-column approach involves the use of a wide-bore fused-silica open tubular column for analysis. The fused-silica, open-tubular wide-bore column offers improved resolution, better selectivity, increased sensitivity, and faster analysis than packed columns.

1.3 The dual-column/dual-detector approach involves the use of two wide-bore fused-silica open-tubular columns of different polarities. The columns are connected to an injection tee and two identical detectors.

1.4 Phenols may be analyzed underivatized by FID, although the sensitivity of the method may not be suitable for all needs.

1.5 This method also includes a procedure for the derivatization of the phenols and identification of the target phenols as methylated phenols (anisoles) and as pentafluorobenzylbromo ether derivatives (PFBBr). Three phenols failed to derivatize under the PFBBr method protocol: 2,4-dinitrophenol, 2-methyl-4,6- dinitrophenol, and Dinoseb.

1.6 The following non-RCRA analytes may also be analyzed by this method:

<u>Compound</u>	<u>CAS No.</u>
2-Chloro-5-methylphenol	615-74-7
4-Chloro-2-methylphenol	1570-64-5
3-Chlorophenol	108-43-0
4-Chlorophenol	106-48-9
2,3-Dichlorophenol	576-24-9
2,5-Dichlorophenol	583-78-8
3,4-Dichlorophenol	95-77-2
3,5-Dichlorophenol	591-35-5
2,3-Dimethylphenol	526-75-0
2,5-Dimethylphenol	95-87-4
2,6-Dimethylphenol	576-26-1
3,4-Dimethylphenol	95-65-8
2,5-Dinitrophenol	329-71-5
3-Nitrophenol	554-84-7
2,3,4-Trichlorophenol	15950-66-0
2,3,5-Trichlorophenol	933-78-8
2,3,6-Trichlorophenol	933-75-5

1.7 This method is restricted to use by or under the supervision of analysts experienced in the use of a gas chromatograph and in the interpretation of gas chromatograms. Each analyst must demonstrate the ability to generate acceptable results with this method.

1.8 Only experienced analysts should be allowed to work with diazomethane due to the potential hazards associated with its use (explosive, carcinogenic).

2.0 SUMMARY OF METHOD

2.1 Samples are extracted using an appropriate sample preparation method. Prior to analysis, the extracts are cleaned up, as necessary, and the solvent exchanged to 2-propanol.

2.2 Underivatized phenols may be analyzed by FID, using either the single-column or dual-column approach.

2.3 The target phenols also may be derivatized with diazomethane or pentafluorobenzyl bromide (PFBBr) and analyzed by gas chromatography.

3.0 INTERFERENCES

3.1 Contamination by carryover can occur whenever high-concentration and low-concentration samples are sequentially analyzed. To reduce carryover, the syringe used for injection must be thoroughly rinsed between samples with solvent. Whenever a highly concentrated sample is encountered, it should be followed by the analysis of a solvent blank to check for cross-contamination. Column blanks should be analyzed whenever the analysis of a solvent blank indicates cross-contamination.

3.2 In certain cases some compounds coelute on either one or both columns. In these cases the compounds must be reported as coeluting. The mixture can be reanalyzed by GC/MS techniques, see Sec. 8.0 and Method 8270.

3.3 Non-specific interferences may occur in the analysis of the underivatized phenols, reducing the sensitivity of the method.

3.4 The phenols listed in Secs. 1.1 and 1.6 were derivatized with α -bromo-2,3,4,5,6-pentafluorotoluene (also known as pentafluorobenzyl bromide, PFBBr) according to the method by Lee, *et al.* (Ref. 1). Five compound pairs coeluted on the DB-5 column and three compound pairs coeluted on the DB-1701 column.

DB-5: 2,6-dimethylphenol/2,5-dimethylphenol
 2,4-dimethylphenol/2-chlorophenol
 2,6-dichlorophenol/4-chloro-2-methylphenol
 2,4,5-trichlorophenol/2,3,5-trichlorophenol
 2,3,4,5-tetrachlorophenol/2,5-dinitrophenol

DB-1701: 3-chlorophenol/3,4-dimethylphenol
 2,4-dichlorophenol/3,5-dichlorophenol
 2,4,5-trichlorophenol/2,3,5-trichlorophenol

In addition, 3-methylphenol is only partially resolved from 4-methylphenol on the two columns, and 2-chlorophenol is only partially resolved from 2,3-dimethylphenol on the DB-1701 column.

As noted above, the PFBBr derivatives of 2,3,5-trichlorophenol and 2,4,5-trichlorophenol coelute on both the DB-5 and DB-1701 columns. Therefore, if these non-RCRA regulated analytes are of concern, the analyst should perform an analysis of the underivatized forms of these compounds (see Sec. 7.2) or employ a GC column with a different stationary phase which permits their separation.

3.5 Sample extracts should be dry prior to methylation or else poor recoveries will be obtained.

4.0 APPARATUS AND MATERIALS

4.1 Gas chromatograph - An analytical system complete with a gas chromatograph suitable for on-column injection, and all required accessories, including syringes, analytical columns, gases, flame ionization detector (FID), electron capture detector (ECD), and a data system.

4.2 GC columns - This method describes procedures for both single-column and dual-column analyses. The single-column approach involves one analysis to determine that a compound is

present, followed by a second analysis to confirm the identity of the compound (Sec. 8.0 describes how GC/MS confirmation techniques may be employed). Both the single-column approach and the dual-column approaches employ wide-bore (0.53 mm ID) columns. The dual-column approach involves a single injection that is split between two columns that are mounted in a single gas chromatograph.

The columns listed in this section were the columns used to develop the method performance data. Listing these columns in this method is not intended to exclude the use of other columns that may be developed. Laboratories may use other capillary columns provided that they document method performance data (e.g., chromatographic resolution, analyte breakdown, and MDLs) that demonstrate performance appropriate for the intended application.

4.2.1 Column 1 - 30 m x 0.53 mm ID fused-silica open-tubular column, cross-linked and chemically bonded with 95 percent dimethyl and 5 percent diphenyl-polysiloxane (DB-5, RT_x-5, SPB-5, or equivalent), 0.83 µm or 1.5 µm film thickness.

4.2.2 Column 2 - 30 m x 0.53 mm ID fused-silica open-tubular column cross-linked and chemically bonded with 14 percent cyanopropylphenyl and 86 percent dimethyl-polysiloxane (DB-1701, RT_x-1701, or equivalent), 1.0 µm film thickness.

4.3 Splitter - When the dual-column approach is employed, the two columns must be connected with a splitter such as those listed below (or equivalent).

4.3.1 J&W Scientific press-fit Y-shaped glass 3-way union splitter (J&W Scientific, Catalog no. 705-0733).

4.3.2 Supelco 8-in glass injection tee, deactivated (Supelco, Catalog no. 2-3665M).

4.3.3 Restek Y-shaped fused-silica connector (Restek, Catalog no. 20405).

4.4 Column rinsing kit - Bonded-phase column rinse kit (J&W Scientific, Catalog no. 430-3000 or equivalent).

4.5 Diazomethane generators - Refer to Sec. 7.3 to determine which method of diazomethane generation should be used for a particular generation.

4.5.2 As an alternative, assemble from two 20 mm x 150 mm test tubes, two Neoprene rubber stoppers, and a source of nitrogen. Use Neoprene rubber stoppers with holes drilled in them to accommodate glass delivery tubes. The exit tube must be drawn to a point to bubble diazomethane through the sample extract. The generator assembly is shown in Figure 6.

4.5.1 Diazald kit - Recommended for the generation of diazomethane (Aldrich Chemical Co., Catalog No. 210,025-0, or equivalent).

4.6 PFBBR Derivatization equipment - 10-mL graduated concentrator tubes with screw caps, disposable pipets, beakers, and water bath.

5.0 REAGENTS

5.1 Reagent grade chemicals shall be used in all tests. Unless otherwise indicated, it is intended that all reagents shall conform to the specifications of the Committee on Analytical Reagents of the American Chemical Society, where such specifications are available. Other grades may be used, provided it is first ascertained that the chemicals are of sufficiently high purity to permit their use without affecting the accuracy of the determinations.

5.2 Store the standard solutions (stock, composite, calibration, internal, and surrogate) at 4°C in polytetrafluoroethylene (PTFE)-sealed containers in the dark. All standard solutions must be replaced after six months or sooner if routine QC (Sec. 8.0) indicates a problem.

5.3 Solvents - all solvents must be pesticide quality or equivalent.

5.3.1 Hexane, C₆H₁₄

5.3.2 Acetone, CH₃COCH₃

5.3.3 Isooctane, (CH₃)₃CCH₂CH(CH₃)₂

5.4 Stock standard solutions (1000 mg/L) - May be prepared from pure standard materials or may be purchased as certified solutions.

5.4.1 Prepare stock standard solutions by accurately weighing about 0.0100 g of pure compound. Dissolve the compound in isooctane or hexane and dilute to volume in a 10 mL volumetric flask. If compound purity is 96 percent or greater, the weight may be used without correction to calculate the concentration of the stock standard solution.

5.4.2 Transfer the stock standard solutions into bottles with PTFE-lined screw-caps or crimp tops. Store at 4°C and protect from light. Stock standards must be replaced after one year or sooner if comparison with check standards indicate a problem. Stock standards should be checked frequently for signs of degradation or evaporation, especially just prior to preparing calibration standards from them.

5.4.3 Commercially-prepared stock standard solutions may be used at any concentration if they are certified by the manufacturer or by an independent source.

5.5 Composite stock standard - May be prepared from individual stock solutions. For composite stock standards containing less than 25 components, transfer exactly 1 mL of each individual stock solution at 1000 mg/L, add solvent, mix the solutions and bring to volume in an appropriate volumetric flask. This composite solution may be further diluted to obtain the desired concentrations.

5.6 Calibration standards - These should be prepared at a minimum of five different concentrations by dilution of the composite stock standard with hexane or other appropriate solvent. The solvent or solvents used to dilute the standards should be the same as the final solvent mixture in the sample extracts to be analyzed. The standard concentrations should correspond to the expected range of concentrations present in the field samples and should bracket the linear range of the detector. Concentrations of the target analytes at 5, 25, 50, 100, and 200 mg/L (except for 2,4- and 2,5-dinitrophenol and 2-methyl-4,6-dinitrophenol at about 2x the given values) have been used as calibration solutions in soil recovery studies. All standards should be prepared from the

target phenols. When derivatization is employed, the phenol standards should be prepared, and then derivatized in the same fashion as the sample extracts, prior to calibration.

5.7 Internal standard - When internal standard calibration is used, prepare a solution of 1000 mg/L of 2,5-dibromotoluene and 2,2',5,5'-tetrabromobiphenyl. For spiking, dilute this solution to 50 ng/ μ L. Use a spiking volume of 10 μ L/mL of extract. The spiking concentration of the internal standards should be kept constant for all samples and calibration standards.

5.8 Surrogate standard - The performance of the method should be monitored using surrogate compounds. Surrogate standards are added to all samples, method blanks, matrix spikes, and calibration standards. Prepare a solution of 1000 mg/L of 2,4-dibromophenol and dilute it to 1.6 ng/ μ L. Use a spiking volume of 100 μ L for a 1 L aqueous sample. Other appropriate surrogates are listed in Sec. 1.6.

5.9 Reagents for derivatization

NOTE: Other derivatization techniques may be employed, provided that the analyst can demonstrate acceptable precision and accuracy for the target compounds (see Sec. 8.0) and for the particular application.

5.9.1 Diazomethane Derivatization

5.9.1.1 N-methyl-N-nitroso-p-toluenesulfonamide (Diazald). High purity (Aldrich Chemical Co., or equivalent).

5.9.1.2 Diethyl Ether stabilized with BHT, C₂H₅OC₂H₅. Must be free of peroxides as indicated by test strips (EM Quant, or equivalent). Procedures for removal of peroxides are provided with the test strips. If ethanol stabilized diethyl ether is used, the methylation reaction may not proceed efficiently.

5.9.1.3 Silicic acid, H₂SiO₅. 100 mesh powder, store at 130°C.

5.9.1.4 HPLC-grade hexane.

5.9.2 PFBBr Derivatization

5.9.2.1 Standards for the target phenols are purchased as phenols and derivatized prior to calibration.

5.9.2.2 α -Bromo-2,3,4,5,6-pentafluorotoluene (PFBBr reagent) - Dissolve 0.500 g of PFBBr in 9.5 mL acetone. Store in the dark at 4°C. Prepare fresh reagent biweekly.

5.9.2.3 Potassium carbonate solution (10 percent) - Dissolve 1 g anhydrous potassium carbonate in water and adjust volume to 10 mL.

5.9.2.4 HPLC-grade acetone.

5.9.2.5 HPLC-grade hexane.

6.0 SAMPLE COLLECTION, PRESERVATION, AND HANDLING

6.1 See the introductory material to this chapter, Organic Analytes, Sec. 4.1.

6.2 It is recommended that extracts to be methylated undergo derivatization within 48 hours after extraction and methylated extracts be analyzed immediately after derivatization to minimize other reactions that may occur.

7.0 PROCEDURE

7.1 Extraction

7.1.1 Refer to Chapter Two and Method 3500 for guidance on choosing the appropriate extraction procedure.

7.1.1.1 Water samples are extracted at a pH of less than or equal to 2 with methylene chloride, using Method 3510 or 3520.

7.1.1.2 Solid samples are extracted using either Method 3540 or 3550, and non-aqueous sample using Method 3580. Acid-Base Partition Cleanup using Method 3650 is suggested for extracts obtained from application of either Method 3540 or 3550.

7.1.1.3 Other aqueous liquid or solid 3500 series extraction techniques in this manual may be appropriate for this method.

7.1.2 If the phenols are to be determined without derivatization, proceed to Sec. 7.2.

7.1.3 If the phenols are to be determined by derivatization, the extraction solvent should be concentrated down to 1 mL using an appropriate concentration technique. If the sample is to be analyzed by GC/ECD the extraction solvent (methylene chloride) will need to be exchanged to hexane or some other nonhalogenated compatible solvent. If methylation with diazomethane is being performed, the sample should be diluted to a final volume of 4 mL with diethyl ether. If PFBBr derivatization is being performed, the sample should be diluted to a final volume of 4 mL with acetone.

NOTE: It is very critical to ensure that the sample is dry when preparing it for methylation. Any moisture remaining in the extract will result in low methylated phenol recoveries. It may be appropriate to add approximately 10 g of acidified anhydrous sodium sulfate to the extract prior to concentration and, periodically, vigorously shake the extract and drying agent. The amount of sodium sulfate is adequate if some free flowing crystals are visible when swirling the flask. If all of the sodium sulfate solidifies in a cake, add a few additional grams of acidified sodium sulfate and again test by swirling. The 2 hour drying time is a minimum, however, the extracts may be held in contact with the sodium sulfate overnight.

7.1.3.1 If the phenols are to be determined by methylation derivatization, proceed to Sec. 7.3.

7.1.3.2 If the phenols are to be determined by PFBBr derivatization, proceed to Sec. 7.4.

7.2 If the phenols are to be determined without derivatization then, prior to gas chromatographic analysis, the extraction solvent must be exchanged to 2-propanol. The exchange is performed as follows:

7.2.1 Concentrate the extract to 1 mL using the macro-Snyder column and allow the apparatus to cool and drain for at least ten minutes.

7.2.2 Remove the micro-Snyder column and rinse its lower joint into the concentrator tube with a small amount of 2-propanol. Adjust the extract volume to 1.0 mL.

7.2.3 Stopper the concentrator tube and store refrigerated at 4°C if further processing will not be performed immediately. If the extract will be stored longer than two days, it should be transferred to a vial with a PTFE-lined screw-cap or crimp top.

7.2.4 If the phenols are to be determined without derivatization, proceed with gas chromatographic calibration and analysis (Secs. 7.5, 7.6, and 7.7).

NOTE: Other derivatization techniques may be employed, provided that the analyst can demonstrate acceptable precision and accuracy for the target compounds (see Sec. 8.0).

7.3 Methylation derivatization procedures

7.3.1 Diazomethane derivatization - Two methods may be used for the generation of diazomethane: the bubbler method, Sec. 7.3.1, and the Diazald kit method, Sec. 7.3.2. The methylation of phenolic compounds for this analysis procedure has been documented for the Diazald kit only (Tables 3 and 4). However, the bubbler method should also be applicable.

CAUTION: Diazomethane is a carcinogen and can explode under certain conditions.

The bubbler method is suggested when small batches of samples (10 - 15) require methylation. The bubbler method works well with samples that have low concentrations of phenols (e.g., aqueous samples) and is safer to use than the Diazald kit procedure. The Diazald kit method is good for large quantities of samples needing methylation. The Diazald kit method is more effective than the bubbler method for soils or samples that may contain high concentrations of phenols (e.g., samples such as soils that may result in yellow extracts following hydrolysis may be difficult to handle by the bubbler method).

The diazomethane derivatization procedures described below will react efficiently with all of the phenols described in this method and should be used only by experienced analysts, due to the potential hazards associated with its use.

The following precautions should be taken:

- Use a safety screen.
- Use mechanical pipetting aides.
- Do not heat above 90°C - EXPLOSION may result.
- Avoid grinding surfaces, ground-glass joints, sleeve bearings, and glass stirrers - EXPLOSION may result.
- Store away from alkali metals - EXPLOSION may result.
- Solutions of diazomethane decompose rapidly in the presence of solid materials such as copper powder, calcium chloride, and boiling chips.

7.3.2 Bubbler method - Assemble the diazomethane bubbler (see Figure 1).

7.3.2.1 Add 5 mL of diethyl ether to the first test tube. Add 1 mL of diethyl ether, 1 mL of carbitol, 1.5 mL of 37% KOH, and 0.1 - 0.2 g of Diazald to the second test tube. Immediately place the exit tube into the concentrator tube containing the sample extract. Apply nitrogen flow (10 mL/min) to bubble diazomethane through the extract for 10 minutes or until the yellow color of diazomethane persists. The amount of Diazald used is sufficient for methylation of approximately three sample extracts. An additional 0.1 - 0.2 g of Diazald may be added (after the initial Diazald is consumed) to extend the generation of the diazomethane. There is sufficient KOH present in the original solution to perform a maximum of approximately 20 minutes of total methylation.

7.3.2.2 Remove the concentrator tube and seal it with a Neoprene or PTFE stopper. Store at room temperature in a hood for 20 minutes.

7.3.2.3 Destroy any unreacted diazomethane by adding 0.1 - 0.2 g of silicic acid to the concentrator tube. Allow to stand until the evolution of nitrogen gas has stopped. Adjust the sample volume to 10.0 mL with hexane. Stopper the concentrator tube or transfer 1 mL of sample to a GC vial, and store refrigerated if further processing will not be performed immediately. Analyze by gas chromatography.

7.3.2.4 Extracts should be stored at 4°C away from light. It is recommended that the methylated extracts be analyzed immediately after derivatization to minimize other reactions that may occur.

7.3.3 Diazald kit method - Instructions for preparing diazomethane are provided with the generator kit.

7.3.3.1 Add 2 mL of diazomethane solution and let the sample stand for 10 minutes with occasional swirling. The yellow color of diazomethane should be evident and should persist for this period.

7.3.3.2 Rinse the inside wall of the ampule with 700 µL of diethyl ether. Reduce the sample volume to approximately 2 mL to remove excess diazomethane by allowing the solvent to evaporate spontaneously at room temperature. Alternatively, 10 mg of silicic acid can be added to destroy the excess diazomethane.

7.3.3.3 Dilute the sample to 10.0 mL with hexane. Analyze by gas chromatography. It is recommended that the methylated extracts be analyzed immediately to minimize other reactions that may occur. Proceed to Sec. 7.5.

7.4 PFBBBr derivatization procedure - Calibration standards and sample extracts should be derivatized using the same procedures.

7.4.1 Using the individual phenol stock solutions at 1000 mg/L make a composite solution and dilute with hexane or other appropriate solvent to the appropriate concentrations for the calibration range of the analysis.

7.4.2 Sample extracts should be in hexane and diluted to 4 mL with acetone according to the procedure in Sec. 7.1.3.

WARNING: PFBBBr is a lachrymator.

7.4.3 Add 100 μL of calibration standards and sample extracts to 8 mL acetone in a 10 mL graduated concentrator tube with screw caps. Add 100 μL of 5% PFBBBr reagent and 100 μL of K_2CO_3 solution to the composite standard.

7.4.4 Cap the tubes tightly and gently shake the contents. Heat the tube in a water bath at 60°C for one hour.

7.4.5 After the reaction is complete, cool the solution and concentrate it to 0.5 mL, using nitrogen blowdown.

7.4.6 Add 3 mL of hexane and concentrate the solution to a final volume of 0.5 mL. If cleanup is not to be performed, proceed to Sec. 7.5 for the analysis of samples by GC/ECD.

7.4.7 Cleanup

7.4.7.1 Refer to Method 3630 (Silica Gel Cleanup) for specific instructions on the cleanup of derivatized phenols.

7.4.7.2 Following column cleanup, proceed to Sec. 7.5 for analysis of the samples using GC/ECD.

7.5 GC Conditions - This method allows the analyst to choose between a single-column or a dual-column configuration in the injector port. Either wide- or narrow-bore columns may be used. Identifications based on retention times from a single-column need to be confirmed on a second column or with an alternative qualitative technique. The recommended gas chromatographic columns and operating conditions for the instrument are provided in Figures 1, 2, 3, and 4 and Table 5.

7.6 Calibration

7.6.1 Prepare the calibration standards according to the guidance in Sec. 5.6. Concentrations of the target analytes at 5, 25, 50, 100, and 200 $\mu\text{g}/\text{mL}$ (except for 2,4- and 2,5-dinitrophenol and 2-methyl-4,6-dinitro-phenol at about 2x the given values) have been used in the past as calibration solutions in soil recovery studies. Calibration standards and sample extracts should be derivatized using the same procedures. External or internal calibration may be used for this procedure. Refer to Sec. 7.0 Method 8000 for guidance on either external and internal calibration techniques.

7.6.2 Establish the GC operating conditions appropriate for the single-column or dual column approach (see Sec. 7.7 and Figure 5). Optimize the instrumental conditions for resolution of the target analytes and sensitivity.

NOTE: Once established, the same operating conditions must be used for both calibrations and sample analyses.

7.6.3 A 2 μL injection volume of each calibration standard is recommended. Other injection volumes may be employed, provided that the analyst can demonstrate adequate sensitivity for the compounds of interest.

7.6.4 Calibration factors - Refer to Sec. 7.0 of Method 8000 for guidance on calculating calibration factors when external calibration is used or on calculating response factors when internal calibration is used.

7.6.5 Retention time windows - Refer to Section 7.0 of Method 8000 for guidance on the establishment of retention time windows.

7.6.6 Initial calibration acceptance criteria - Refer to Section 7.0 of Method 8000 for guidance on initial calibration linearity and acceptance criteria.

7.7 Gas chromatographic analysis of sample extracts

7.7.1 Inject a 2 μL aliquot of the concentrated sample extract. Record the volume injected to the nearest 0.05 μL and the resulting peak size in area units. The same GC operating conditions used for the initial calibration must be employed for samples analyses.

NOTE: When using internal standard calibration, add 10 μL of the internal standard solution to the sample extract prior to injection.

7.7.2 Calibration verification - Verify calibration by injecting calibration verification a standard prior to conducting any sample analyses. Sample injections may continue for as long as the calibration verification standards and standards interspersed with the samples meet instrument QC requirements. It is *recommended* that standards be analyzed after every 10 samples (*required* after every 20 samples and at the end of a set) to minimize the number of samples that must be re-inject when the standards fail the QC limits. The sequence ends when the set of samples has been injected or when qualitative and/or quantitative QC criteria are exceeded. Each sample analysis must be bracketed with an acceptable initial calibration or calibration verification standards interspersed between the sample analyses. When a calibration verification standard fails to meet the QC criteria, all samples that were injected after the last standard that last met the QC criteria must be re-injected.

7.7.2.1 The calibration factor for each analyte to be quantitated must not exceed a ± 15 percent difference when compared to the initial calibration curve. Refer to Section 7.0 of Method 8000 for guidance on the proper calculation of percent difference using either calibration factors or response factors.

7.7.2.2 If this criterion is exceeded, inspect the gas chromatographic system to determine the cause and perform whatever maintenance is necessary before verifying calibration and proceeding with sample analysis.

7.7.2.3 If routine maintenance does not return the instrument performance to meet the QC requirements (Sec. 7.9) based on the last initial calibration, then a new initial calibration must be performed.

7.7.3 Compare the retention time of each analyte in the calibration standard with the absolute retention time windows established in Sec. 7.6.5. As described in Method 8000, the center of the absolute retention time window for each analyte is its retention time in the mid-concentration standard analyzed during the initial calibration. Each analyte in each standard must fall within its respective retention time window. If not, the gas chromatographic system must either be adjusted so that a second analysis of the standard does result in all analytes falling within their retention time windows, or a new initial calibration must be performed and new retention time windows established.

7.7.4 Tentative identification of an analyte occurs when a peak from a sample extract falls within the absolute retention time window. Each tentative identification must be confirmed using either a second GC column of dissimilar stationary phase or using another technique

such as GC/MS (see Sec. 8.6). When using the dual-column technique, additional confirmation is not required, provided that the analyte meets the identification criteria in both columns.

7.7.5 Refer to Section 7.0 of Method 8000 for calculation of results from either external or internal calibration. Both external and internal standard quantitation can be applied to the analysis of either the underivatized or derivatized phenols, provided that the initial calibration is performed on the same type of standards.

7.7.5.1 Proper quantitation requires the appropriate selection of a baseline from which the peak area or height can be determined.

7.7.5.2 If the responses exceed the calibration range of the system, dilute the extract and reanalyze. Peak height measurements are recommended over peak area integration when overlapping peaks cause errors in area integration.

7.7.5.3 If partially overlapping or coeluting peaks are found, change columns or try GC/MS quantitation, see Sec. 8 and Method 8270.

7.8 Confirmation

7.8.1 When the single-column approach is employed, all target phenols must have their identities confirmed. Confirmatory techniques such as gas chromatography with a dissimilar column, specific element detector, or mass spectrometer should be used. Refer to Method 8000 for further information on confirmation.

7.8.2 When the dual-column approach is employed, the target phenols are identified and confirmed when they meet the identification criteria on both columns.

7.9 Suggested chromatograph maintenance - Corrective measures may require one or more of the following remedial actions.

7.9.1 Splitter connections - For dual columns which are connected using a press-fit Y-shaped glass splitter or a Y-shaped fused-silica connector (J&W Scientific, Restek, Supelco, or equivalent), clean and deactivate the splitter port insert or replace with a cleaned and deactivated splitter. Break off a few inches (up to one foot) of the injection port side of the column. Remove the columns and solvent backflush according to the manufacturer's instructions. If these procedures fail to eliminate the degradation problem, it may be necessary to deactivate the metal injector body and/or replace the columns.

7.9.2 Metal injector body - Turn off the oven and remove the analytical columns when the oven has cooled. Remove the glass injection port insert (instruments with on-column injection). Reduce the injection port temperature to room temperature. Inspect the injection port and remove any visible foreign material.

7.9.2.1 Place a beaker beneath the injector port inside the oven. Using a wash bottle, serially rinse the entire inside of the injector port with acetone and then toluene.

7.9.2.2 Prepare a solution of a deactivating agent (Sylon-CT or equivalent) following manufacturer's directions. After all metal surfaces inside the injector body have been thoroughly coated with the deactivation solution, serially rinse the injector body with

toluene, methanol, acetone, and hexane. Reassemble the injector and replace the columns.

7.9.3 Column rinsing - The column should be rinsed with several column volumes of an appropriate solvent. Both polar and nonpolar solvents are recommended. Depending on the nature of the sample residues expected, the first rinse might be water, followed by methanol and acetone; methylene chloride is a satisfactory final rinse and in some cases may be the only solvent required. The column should then be filled with methylene chloride and allowed to remain flooded overnight to allow materials within the stationary phase to migrate into the solvent. The column is then flushed with fresh methylene chloride, drained, and dried at room temperature with a stream of ultrapure nitrogen passing through the column.

8.0 QUALITY CONTROL

8.1 Refer to Chapter One and Method 8000 for specific quality control (QC) procedures. QC to validate sample extraction is covered in Method 3500 and in the extraction method utilized. If extract cleanup was performed, follow the QC in Method 3600 and in the specific cleanup method. Each laboratory should maintain a formal quality assurance program. The laboratory should also maintain records to document the quality of the data generated.

8.2 Quality control necessary to evaluate the GC system operation is found in Method 8000, Sec. 7.0 under Retention Time Windows, Calibration Verification, and Chromatographic Analysis of Samples.

8.3 Initial Demonstration of Proficiency - Each laboratory must demonstrate initial proficiency with each sample preparation and determinative method combination it utilizes, by generating data of acceptable accuracy and precision for target analytes in a clean matrix. The laboratory must also repeat the following operations whenever new staff are trained or significant changes in instrumentation are made. If appropriate, it is suggested that the quality control (QC) reference sample concentrate contain each analyte of interest at 20 mg/L. See Method 8000, Sec. 8.0 for information on how to accomplish this demonstration.

8.4 Sample Quality Control for Preparation and Analysis - The laboratory must also have procedures for documenting the effect of the matrix on method performance (precision, accuracy, and detection limit). At a minimum, this includes a method blank, matrix spike, a duplicate, a laboratory control sample (LCS), and the use of surrogate spikes in each analytical batch.

8.4.1 Documenting the effect of the matrix should include the analysis of at least one matrix spike and one duplicate unspiked sample or one matrix spike/matrix spike duplicate pair. The decision on whether to prepare and analyze duplicate samples or a matrix spike/matrix spike duplicate must be based on a knowledge of the samples in the sample batch. If samples are expected to contain target analytes, then laboratories may use one matrix spike and a duplicate analysis of an unspiked field sample. If samples are not expected to contain target analytes, the laboratories should use a matrix spike and matrix spike duplicate pair.

8.4.2 In-house method performance criteria should be developed using the guidance found in Sec. 8.0 of Method 8000.

8.4.3 A Laboratory Control Sample (LCS) should be included with each analytical batch. The LCS consists of an aliquot of a clean (control) matrix similar to the sample matrix and of the same weight or volume. The LCS is spiked with the same analytes at the same

concentrations as the matrix spike. When the results of the matrix spike analysis indicates a potential problem due to the sample matrix itself, the LCS results are used to verify that the laboratory can perform the analysis in a clean matrix.

8.4.4 See Method 8000, Sec. 8.0 for the details on carrying out sample quality control for preparation and analysis.

8.5 Surrogate recoveries: The laboratory should evaluate surrogate recovery data from individual samples versus the surrogate control limits developed by the laboratory. See Method 8000, Sec. 8.0 for information on evaluating surrogate data and developing and updating surrogate limits.

8.6 It is recommended that the laboratory adopt additional quality assurance practices for use with this method. The specific practices that are most productive depend upon the needs of the laboratory and the nature of the samples. Whenever possible, the laboratory should analyze standard reference materials and participate in relevant performance evaluation studies.

9.0 METHOD PERFORMANCE

9.1 Tables 1 and 2 list the retention times and recovery data for the underivatized analytes from sandy, loam soil that may be determined by this method. Figures 1 and 2 provide chromatograms and GC operating conditions of those analyses.

9.2 Tables 3 and 4 list the retention times for some of the methylated analytes that may be determined by this method. Figures 3 and 4 provide chromatograms and GC operating conditions of those analyses.

9.3 Table 5 lists the retention times for the PFB derivatives of the analytes that may be determined by this method. Figure 5 provides a chromatogram of the analytes under the GC conditions listed in Table 6.

10.0 REFERENCES

1. Lee, H. B.; Weng, L. D.; Chau, A. S. Y. *J. Assoc. Off. Anal. Chem.* 1984, 67, 6, 1086-1090.
2. Lopez-Avila, V.; Baldin, E.; Benedicto, J.; Milanés, J.; Beckert, W. F. "Application of Open-Tubular Columns to SW-846 GC Methods"; final report to the U.S. Environmental Protection Agency on Contract 68-03-3511; Mid-Pacific Environmental Laboratory, Mountain View, CA, 1990.
3. Tsang, S.; Marsden, P.; Chau, N. "Performance Data for Methods 8041, 8091, 8111, and 8121A"; draft report to U.S. Environmental Protection Agency on Contract 68-W9-0011; Science Applications International Corp., San Diego, CA, 1992.

TABLE 1

RETENTION TIMES AND RECOVERIES ^a OF UNDERIVATIZED PHENOLS (MIX 1)				
Analyte	R _t , min	Spiking Conc. (µg/g)	Recovery (%)	% RSD
Phenol	6.37	20	93	16.9
2-Methylphenol	8.17	20	95	13.6
3-Methylphenol	8.65	20	98	10.3
2,4-Dimethylphenol	9.63	20	93	11.5
2,6-Dimethylphenol	10.54	20	101	8.1
2,3-Dimethylphenol	11.32	20	106	7.1
3-Chlorophenol	11.68	20	116	6.7
4-Chloro-3-methylphenol	14.07	20	128	3.8
2,3,5-Trichlorophenol	15.47	20	136	4.1
2,4,5-Trichlorophenol	16.05	20	139	3.0
2,5-Dinitrophenol	18.37	40	177	5.1
2,4-Dinitrophenol	19.29	40	157	7.3
2,3,5,6-Tetrachlorophenol	20.42	20	236	3.5
2-methyl-4,6-dinitrophenol	21.72	40	201	3.8
Dinoseb	25.71	20	210	4.9

^a Five 5 g aliquots of clean, sandy loam soil were spiked separately and extracted using Method 3540 (Soxhlet) with methylene chloride as a solvent.

TABLE 2

RETENTION TIMES AND RECOVERIES ^a OF UNDERIVATIZED PHENOLS (MIX 2)				
Analyte	R _t , min	Spiking Conc. (µg/g)	Recovery (%)	% RSD
2-Chlorophenol	6.91	20	93	11.6
4-Methylphenol	8.64	20	96	3.4
2,5-Dimethylphenol	10.42	20	101	2.6
2-Nitrophenol	10.58	20	99	2.8
2,4-Dichlorophenol	11.29	20	102	2.5
2,6-Dichlorophenol	12.18	20	104	2.8
2,4,6-Trichlorophenol	15.91	20	122	2.7
2,3,6-Trichlorophenol	16.68	20	125	2.6
3-Nitrophenol	18.37	20	124	4.0
4-Nitrophenol	19.61	20	123	5.6
2,3,4,6-Tetrachlorophenol	20.60	20	146	3.3
Pentachlorophenol	24.85	20	168	5.0

^a Five 5 g aliquots of clean, sandy loam soil were spiked separately and extracted using Method 3540 (Soxhlet) with methylene chloride as a solvent.

TABLE 3

RETENTION TIMES OF METHYLATED PHENOLS (MIX 1)	
Analyte (derivatized)	R _t , min
2,3,5-Trichlorophenol	15.87 ^a
2,4,5-Trichlorophenol	15.87 ^a
2,3,5,6-Tetrachlorophenol	17.50
2,5-Dinitrophenol	20.07
2-methyl-4,6-dinitrophenol	20.92
2,4-Dinitrophenol	22.15
Dinoseb	23.87

^a Co-eluting analytes.

TABLE 4

RETENTION TIMES OF METHYLATED PHENOLS (MIX 2)	
Analyte (derivatized)	R _t , min
2,6-Dichlorophenol	10.02
2,4-Dichlorophenol	12.07
2,4,6-Trichlorophenol	13.12
2-Nitrophenol	13.48 ^a
3-Nitrophenol	13.48 ^a
2,3,6-Trichlorophenol	14.15
4-Nitrophenol	14.64
2,3,4,6-Tetrachlorophenol	17.56
Pentachlorophenol	21.54

^a Co-eluting analytes.

TABLE 5

RETENTION TIMES OF PFBBR DERIVATIVES OF PHENOLS^a

Compound	CAS No.	DB-5 RT (min)	DB-1701 RT (min)
Phenol	108-95-2	4.69	6.36
2-Methylphenol	5-48-7	5.68	7.44
3-Methylphenol	108-39-4	6.05	7.99
4-Methylphenol	106-44-5	6.21	8.13
2,6-Dimethylphenol	576-26-1	7.08	8.83
2,5-Dimethylphenol	95-87-4	7.08	9.02
2,4-Dimethylphenol	105-67-9	7.34	9.27
2,3-Dimethylphenol	526-75-0	7.96	10.11
2-Chlorophenol	95-57-8	7.34	10.24
3-Chlorophenol	108-43-0	7.86	10.78
3,4-Dimethylphenol	95-65-8	8.46	10.78
4-Chlorophenol	106-48-9	8.19	11.31
2-Chloro-5-methylphenol	615-74-7	9.12	12.25
2,6-Dichlorophenol	87-65-0	9.73	12.52
4-Chloro-2-methylphenol	1570-64-5	9.73	12.89
4-Chloro-3-methylphenol	59-50-7	10.18	13.31
2,5-Dichlorophenol	583-78-8	10.71	14.37
3,5-Dichlorophenol	591-35-5	11.02	14.75
2,4-Dichlorophenol	120-83-2	11.02	14.75
2,4,6-Trichlorophenol	88-06-2	12.85	15.76
2,3-Dichlorophenol	576-24-9	12.01	16.22
3,4-Dichlorophenol	95-77-2	12.51	16.67
2,3,6-Trichlorophenol	933-75-5	13.93	17.36
2-Nitrophenol	88-75-5	12.51	19.19
2,4,5-Trichlorophenol	95-95-4	15.02	19.35
2,3,5-Trichlorophenol	933-78-8	15.02	19.35
3-Nitrophenol	554-84-7	13.69	20.06
2,3,5,6-Tetrachlorophenol	935-95-5	17.71	21.18
2,3,4,6-Tetrachlorophenol	58-90-2	17.96	21.49
2,3,4-Trichlorophenol	15950-66-0	16.81	21.76
4-Nitrophenol	100-02-7	15.69	22.93
2,3,4,5-Tetrachlorophenol	4901-51-3	20.51	25.52
Pentachlorophenol	87-86-5	22.96	26.81
2,5-Dinitrophenol	329-71-5	20.51	30.15
2,5-Dibromotoluene (IS)	615-59-8	3.16	3.18
2,2',5,5'-Tetrabromobiphenyl (IS)	59080-37-4	25.16	28.68
2,4-Dibromophenol (Surr.)	615-58-7	16.02	20.56

^a See Table 6 for GC operating conditions.

IS = Internal Standard

Surr. = Surrogate

TABLE 6

OPERATING CONDITIONS FOR PFBB_r DERIVATIVES OF PHENOLS
DUAL-COLUMN APPROACH

Column 1:	DB-5 (J&W Scientific) Dimensions: 30 m x 0.53 mm ID Film Thickness (μm): 0.83
Column 2:	DB-1701 (J&W Scientific) Dimensions: 30 m x 0.53 mm ID Film Thickness (μm): 1.0
Carrier gas:	Helium
Flow rate:	6 mL/min
Makeup gas:	Nitrogen
Flow rate:	20 mL/min
Temperature program:	1 min hold 150°C to 275°C at 3°C/min 2 min hold
Injector temperature:	250°C
Detector temperature:	320°C
Injection volume:	2 μL
Solvent:	Hexane
Type of injector:	Flash vaporization
Detector type:	Dual ECD
Type of splitter:	Supelco 8-in injection tee

FIGURE 1

ANALYSIS OF UNDERIVATIZED PHENOLS FROM SOXHLET EXTRACTION - MIX 1
(See Table 1 for peak assignments.)

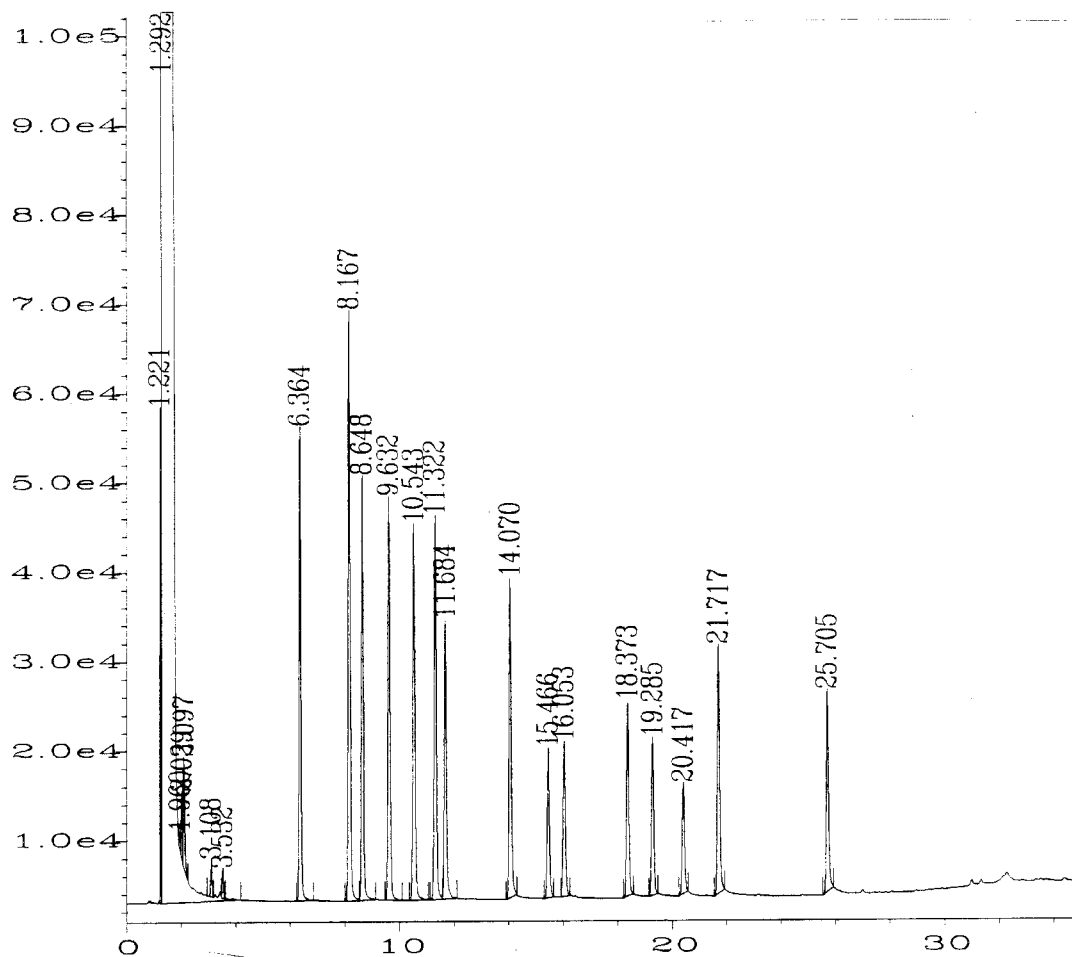

Operating Conditions:

Column: DB-5 30 m x 0.53 mm id
Injector: Packed, megabore liner, 200°C
Carrier gas: Nitrogen, 6 mL/min
Hydrogen: 30 mL/min
Total Nitrogen: 30 mL/min (carrier and makeup)
Detector: FID, 300°C
Temperature program: 80°C held for 1.5 minutes
6°C/min to 230°C
10°C/min to 275°C and held for 4.5 minutes

FIGURE 2

ANALYSIS OF UNDERIVATIZED PHENOLS BY SOXHLET EXTRACTION - MIX 2
(See Table 2 for peak assignments.)

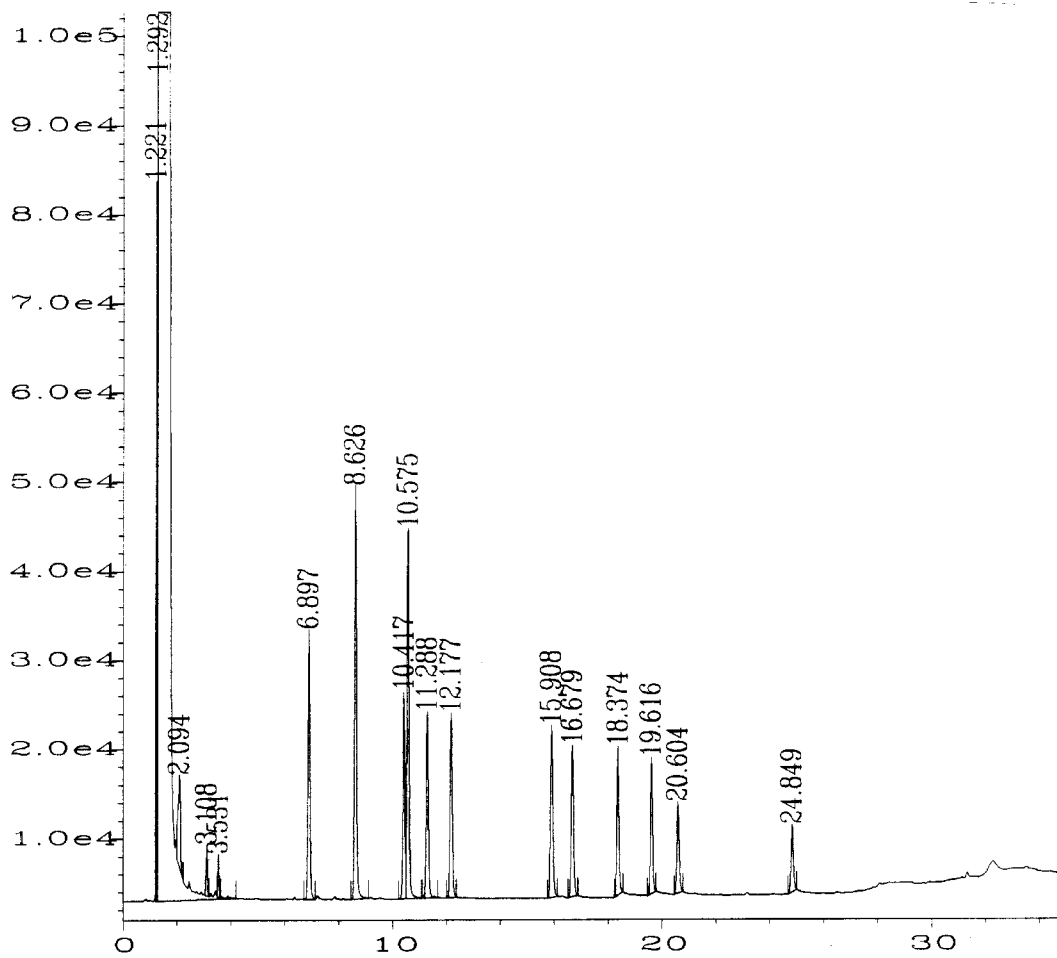

Operating Conditions:

Column: DB-5 30 m x 0.53 mm id

Injector: Packed, megabore liner, 200°C

Carrier gas: Nitrogen, 6 mL/min

Hydrogen: 30 mL/min

Total Nitrogen: 30 mL/min (carrier and makeup)

Detector: FID, 300°C

Temperature program: 80°C held for 1.5 minutes
6°C/min to 230°C
10°C/min to 275°C and held for 4.5 minutes

FIGURE 3

ANALYSIS OF METHYLATED PHENOLS BY SOXHLET EXTRACTION - MIX 1
(See Table 3 for peak assignments.)

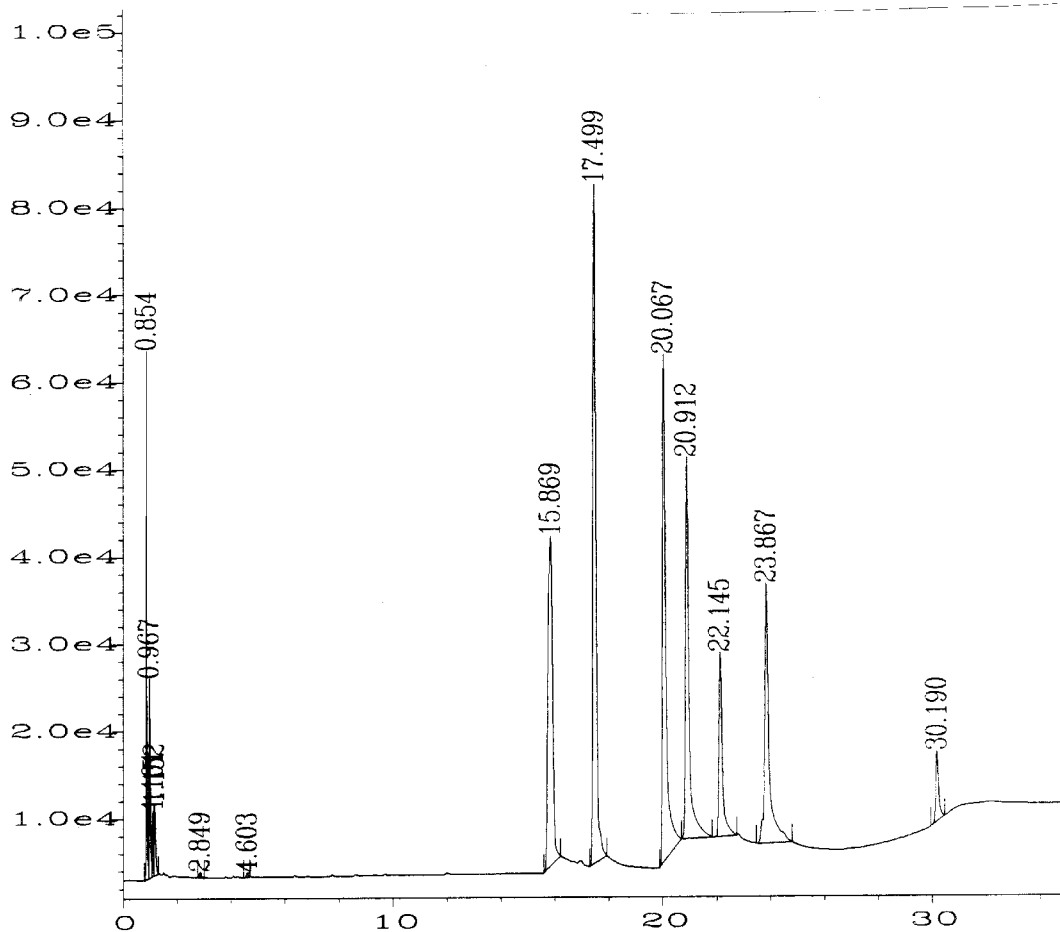

Operating Conditions:

Column: DB-5 30 m x 0.53 mm id

Injector: Packed, megabore liner, 200°C

Carrier gas: Nitrogen, 6 mL/min

Hydrogen: 30 mL/min

Total Nitrogen: 30 mL/min (carrier and makeup)

Detector: FID, 300°C

Temperature program:

80°C held for 1.5 minutes

6°C/min to 230°C

10°C/min to 275°C and held for 4.5 minutes

FIGURE 4

ANALYSIS OF METHYLATED PHENOLS BY SOXHLET EXTRACTION - MIX 2
(See Table 4 for peak assignments.)

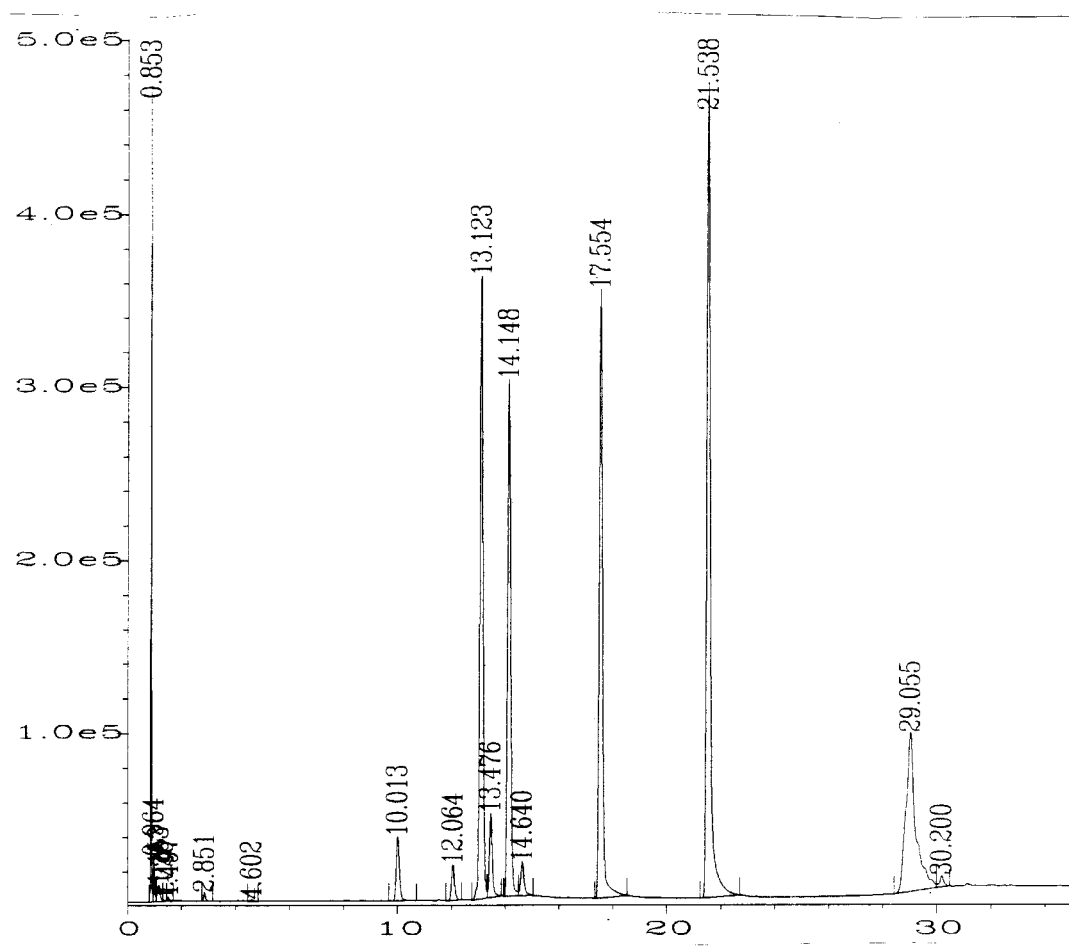

Operating Conditions:

Column: DB-5 30 m x 0.53 mm id
Injector: Packed, megabore liner, 200°C
Carrier gas: Nitrogen, 6 mL/min
Hydrogen: 30 mL/min
Total Nitrogen: 30 mL/min (carrier and makeup)
Detector: FID, 300°C
Temperature program: 80°C held for 1.5 minutes
6°C/min to 230°C
10°C/min to 275°C and held for 4.5 minutes

FIGURE 5

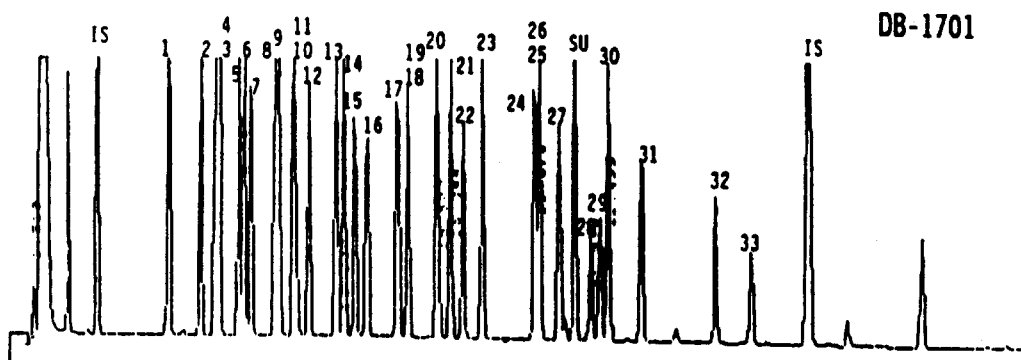
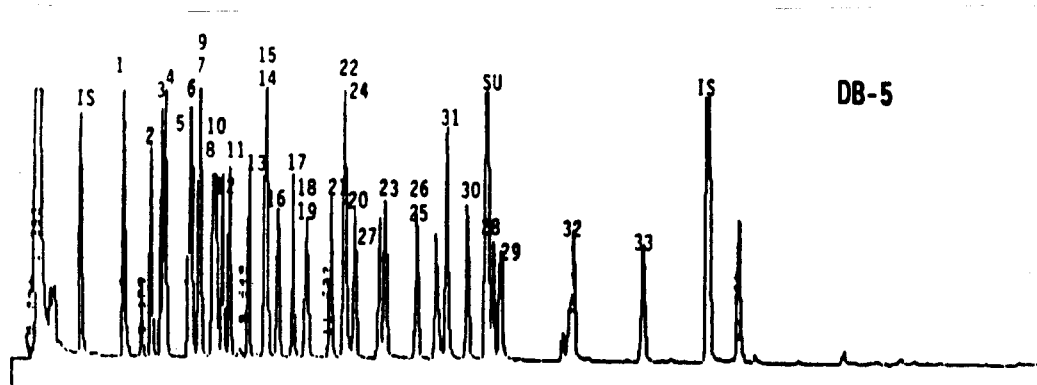

GC/ECD chromatogram of the PFB derivatives of phenolic compounds analyzed on a DB-5/DB-1701 fused-silica open-tubular column pair. The GC operating conditions were as follows: 30 m x 0.53 mm ID DB-5 (0.83 μ m film thickness) and 30 m x 0.53 mm ID DB-1701 (1.0 μ m film thickness) connected to an 8" injection tee (Supelco Inc.). Temperature program: 150°C (1 min hold) to 275°C (2 min hold) at 30°C/min.

FIGURE 6
DIAZOMETHANE GENERATOR

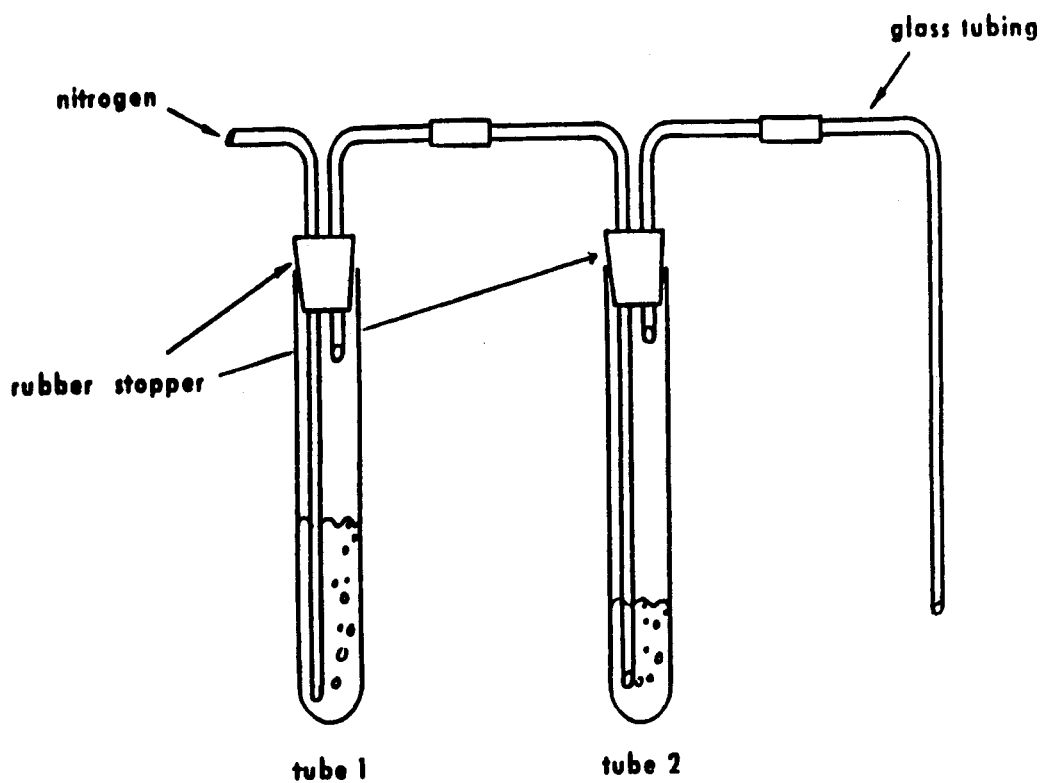

METHOD 8041

PHENOLS BY GAS CHROMATOGRAPHY

